

DM74LS245 3-STATE Octal Bus Transceiver

General Description

These octal bus transceivers are designed for asynchronous two-way communication between data buses. The control function implementation minimizes external timing requirements.

The device allows data transmission from the A Bus to the B Bus or from the B Bus to the A Bus depending upon the logic level at the direction control (DIR) input. The enable input (\bar{G}) can be used to disable the device so that the buses are effectively isolated.

Features

- Bi-Directional bus transceiver in a high-density 20-pin package
- 3-STATE outputs drive bus lines directly
- PNP inputs reduce DC loading on bus lines
- Hysteresis at bus inputs improve noise margins
- Typical propagation delay times, port-to-port 8 ns
- Typical enable/disable times 17 ns
- I_{OL} (sink current)
24 mA
- I_{OH} (source current)
-15 mA

Ordering Code:

| Order Number | Package Number | Package Description |
|--------------|----------------|---|
| DM74LS245WM | M20B | 20-Lead Small Outline Integrated Circuit (SOIC), JEDEC MS-013, 0.300 Wide |
| DM74LS245SJ | M20D | 20-Lead Small Outline Package (SOP), EIAJ TYPE II, 5.3mm Wide |
| DM74LS245N | N20A | 20-Lead Plastic Dual-In-Line Package (PDIP), JEDEC MS-001, 0.300 Wide |

Devices also available in Tape and Reel. Specify by appending the suffix letter "X" to the ordering code.

Connection Diagram

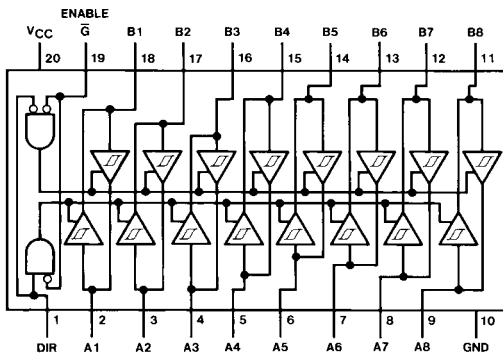

Function Table

| Enable \bar{G} | Direction Control DIR | Operation |
|---------------------|-----------------------------|-----------------|
| L | L | B Data to A Bus |
| L | H | A Data to B Bus |
| H | X | Isolation |

H = HIGH Level
L = LOW Level
X = Irrelevant

Absolute Maximum Ratings(Note 1)

| | |
|--------------------------------------|-----------------|
| Supply Voltage | 7V |
| Input Voltage | |
| DIR or \bar{G} | 7V |
| A or B | 5.5V |
| Operating Free Air Temperature Range | 0°C to +70°C |
| Storage Temperature Range | -65°C to +150°C |

Note 1: The "Absolute Maximum Ratings" are those values beyond which the safety of the device cannot be guaranteed. The device should not be operated at these limits. The parametric values defined in the Electrical Characteristics tables are not guaranteed at the absolute maximum ratings. The "Recommended Operating Conditions" table will define the conditions for actual device operation.

Recommended Operating Conditions

| Symbol | Parameter | Min | Nom | Max | Units |
|----------|--------------------------------|------|-----|------|-------|
| V_{CC} | Supply Voltage | 4.75 | 5 | 5.25 | V |
| V_{IH} | HIGH Level Input Voltage | 2 | | | V |
| V_{IL} | LOW Level Input Voltage | | | 0.8 | V |
| I_{OH} | HIGH Level Output Current | | | -15 | mA |
| I_{OL} | LOW Level Output Current | | | 24 | mA |
| T_A | Free Air Operating Temperature | 0 | | 70 | °C |

Electrical Characteristics

over recommended operating free air temperature range (unless otherwise noted)

| Symbol | Parameter | Conditions | Min | Typ (Note 2) | Max | Units | |
|-----------|---|---|---|-----------------|------------|---------------|----|
| V_I | Input Clamp Voltage | $V_{CC} = \text{Min}$, $I_I = -18 \text{ mA}$ | | | -1.5 | V | |
| HYS | Hysteresis ($V_{T+} - V_{T-}$) | $V_{CC} = \text{Min}$ | 0.2 | 0.4 | | V | |
| V_{OH} | HIGH Level Output Voltage | $V_{CC} = \text{Min}$, $V_{IH} = \text{Min}$ $V_{IL} = \text{Max}$, $I_{OH} = -1 \text{ mA}$ | 2.7 | | | V | |
| | | $V_{CC} = \text{Min}$, $V_{IL} = \text{Min}$ $V_{IL} = \text{Max}$, $I_{OH} = -3 \text{ mA}$ | 2.4 | 3.4 | | | |
| | | $V_{CC} = \text{Min}$, $V_{IH} = \text{Min}$ $V_{IL} = 0.5V$, $I_{OH} = \text{Max}$ | 2 | | | | |
| V_{OL} | LOW Level Output Voltage | $V_{CC} = \text{Min}$ $V_{IL} = \text{Max}$ $V_{IH} = \text{Min}$ | $I_{OL} = 12 \text{ mA}$ $I_{OL} = \text{Max}$ | | 0.4 0.5 | V | |
| | | | | | | | |
| I_{OZH} | Off-State Output Current, HIGH Level Voltage Applied | $V_{CC} = \text{Max}$ $V_{IL} = \text{Max}$ | $V_O = 2.7V$ | | 20 | μA | |
| I_{OZL} | Off-State Output Current, LOW Level Voltage Applied | $V_{IH} = \text{Min}$ | $V_O = 0.4V$ | | -200 | μA | |
| I_I | Input Current at Maximum Input Voltage | $V_{CC} = \text{Max}$ | A or B $V_I = 5.5V$ | | 0.1 | mA | |
| | | | DIR or \bar{G} $V_I = 7V$ | | 0.1 | | |
| I_{IH} | HIGH Level Input Current | $V_{CC} = \text{Max}$, $V_I = 2.7V$ | | | 20 | μA | |
| I_{IL} | LOW Level Input Current | $V_{CC} = \text{Max}$, $V_I = 0.4V$ | | | -0.2 | mA | |
| I_{OS} | Short Circuit Output Current | $V_{CC} = \text{Max}$ (Note 3) | | -40 | -225 | mA | |
| I_{CC} | Supply Current | $V_{CC} = \text{Max}$ | Outputs HIGH | | 48 | 70 | mA |
| | | | Outputs LOW | | 62 | 90 | |
| | | | Outputs at Hi-Z | | 64 | 95 | |

Note 2: All typicals are at $V_{CC} = 5V$, $T_A = 25^\circ\text{C}$.

Note 3: Not more than one output should be shorted at a time, not to exceed one second duration

| Switching Characteristics | | | | | |
|----------------------------------|---|--|------------|------------|--------------|
| $V_{CC} = 5V, T_A = 25^\circ C$ | | | | | |
| Symbol | Parameter | Conditions | Min | Max | Units |
| t_{PLH} | Propagation Delay Time, LOW-to-HIGH Level Output | $C_L = 45\text{ pF}$ $R_L = 667\Omega$ | | 12 | ns |
| t_{PHL} | Propagation Delay Time, HIGH-to-LOW Level Output | | | 12 | ns |
| t_{PZL} | Output Enable Time to LOW Level | | | 40 | ns |
| t_{PZH} | Output Enable Time to HIGH Level | | | 40 | ns |
| t_{PLZ} | Output Disable Time from LOW Level | $C_L = 5\text{ pF}$ $R_L = 667\Omega$ | | 25 | ns |
| t_{PHZ} | Output Disable Time from HIGH Level | | | 25 | ns |
| t_{PLH} | Propagation Delay Time, LOW-to-HIGH Level Output | $C_L = 150\text{ pF}$ $R_L = 667\Omega$ | | 16 | ns |
| t_{PHL} | Propagation Delay Time, HIGH-to-LOW Level Output | | | 17 | ns |
| t_{PZL} | Output Enable Time to LOW Level | | | 45 | ns |
| t_{PZH} | Output Enable Time to HIGH Level | | | 45 | ns |

Physical Dimensions inches (millimeters) unless otherwise noted

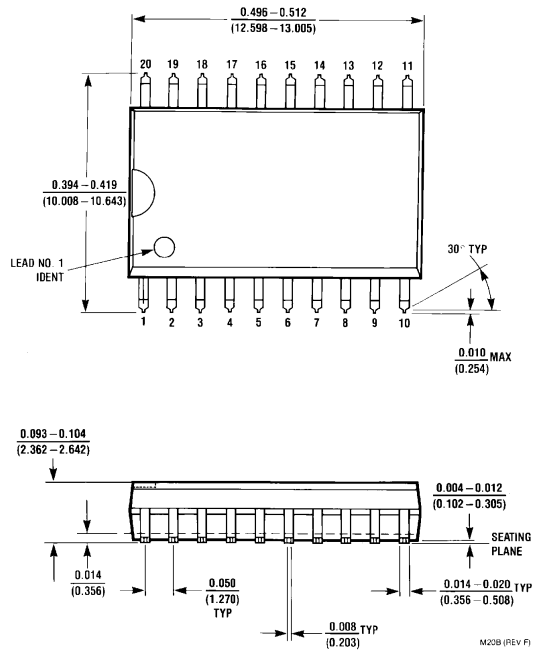

**20-Lead Small Outline Integrated Circuit (SOIC), JEDEC MS-013, 0.300 Wide
Package Number M20B**

Physical Dimensions inches (millimeters) unless otherwise noted (Continued)

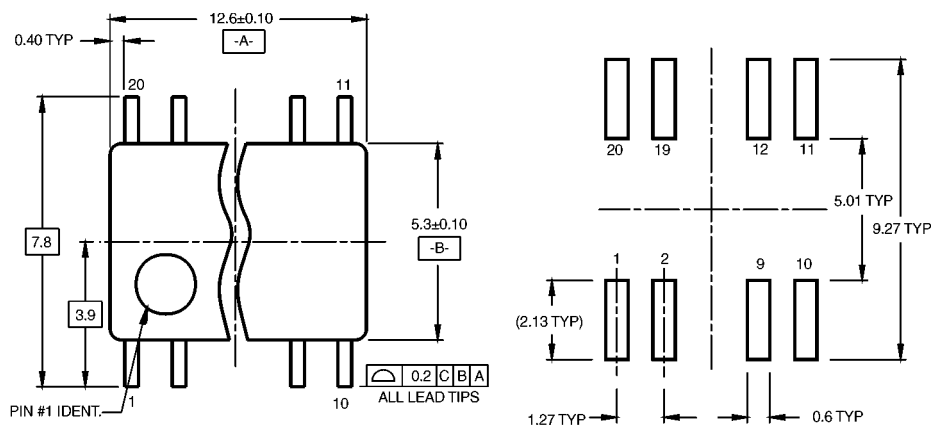

LAND PATTERN RECOMMENDATION

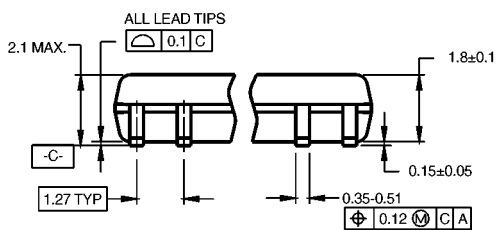

DIMENSIONS ARE IN MILLIMETERS

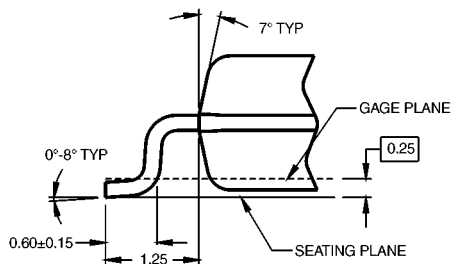
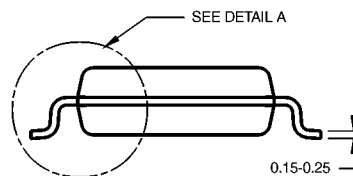

DETAIL A

- NOTES:
- A. CONFORMS TO EIAJ EDR-7320 REGISTRATION, ESTABLISHED IN DECEMBER, 1998.
 - B. DIMENSIONS ARE IN MILLIMETERS.
 - C. DIMENSIONS ARE EXCLUSIVE OF BURRS, MOLD FLASH, AND TIE BAR EXTRUSIONS.

M20DRevB1

**20-Lead Small Outline Package (SOP), EIAJ TYPE II, 5.3mm Wide
Package Number M20D**

Physical Dimensions inches (millimeters) unless otherwise noted (Continued)

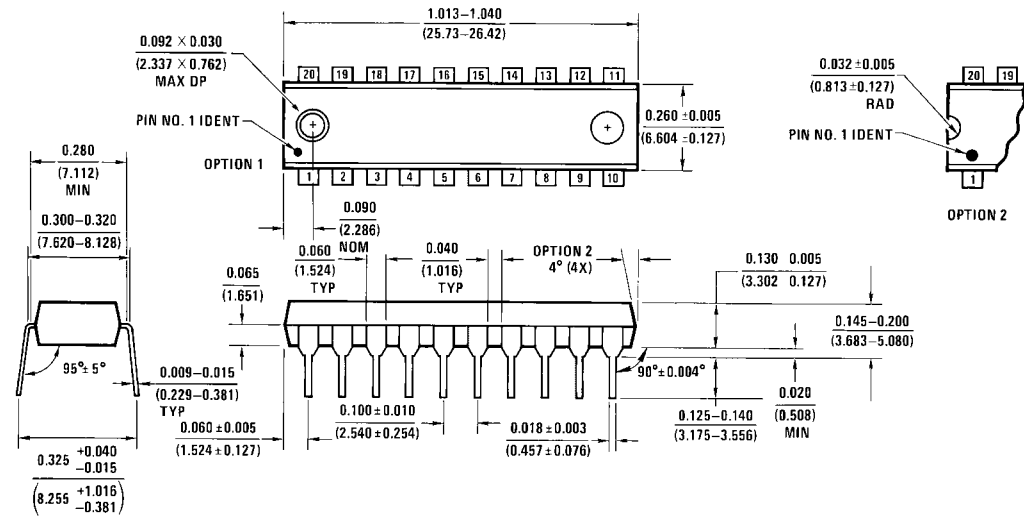

**20-Lead Plastic Dual-In-Line Package (PDIP), JEDEC MS-001, 0.300 Wide
Package Number N20A**

Fairchild does not assume any responsibility for use of any circuitry described, no circuit patent licenses are implied and Fairchild reserves the right at any time without notice to change said circuitry and specifications.

LIFE SUPPORT POLICY

FAIRCHILD'S PRODUCTS ARE NOT AUTHORIZED FOR USE AS CRITICAL COMPONENTS IN LIFE SUPPORT DEVICES OR SYSTEMS WITHOUT THE EXPRESS WRITTEN APPROVAL OF THE PRESIDENT OF FAIRCHILD SEMICONDUCTOR CORPORATION. As used herein:

1. Life support devices or systems are devices or systems which, (a) are intended for surgical implant into the body, or (b) support or sustain life, and (c) whose failure to perform when properly used in accordance with instructions for use provided in the labeling, can be reasonably expected to result in a significant injury to the user.
2. A critical component in any component of a life support device or system whose failure to perform can be reasonably expected to cause the failure of the life support device or system, or to affect its safety or effectiveness.

www.fairchildsemi.com